

Learning From an Envisioned Future - An Empirical Account

Kaiser, Alexander; Kragulj, Florian; Grisold, Thomas; Walser, Roman

Published in:
Electronic Journal of Knowledge Management

DOI:
[10.13140/RG.2.1.4772.7767](https://doi.org/10.13140/RG.2.1.4772.7767)

Published: 01/01/2016

Document Version
Unknown

[Link to publication](#)

Citation for published version (APA):

Kaiser, A., Kragulj, F., Grisold, T., & Walser, R. (2016). Learning From an Envisioned Future - An Empirical Account. *Electronic Journal of Knowledge Management*, 14(1), 18 - 30.
<https://doi.org/10.13140/RG.2.1.4772.7767>

Learning from an Envisioned Future: An Empirical Account

Alexander Kaiser, Florian Kragulj, Thomas Grisold and Roman Walser

Vienna University of Economics and Business, Vienna, Austria

alexander.kaiser@wu.ac.at

florian.kragulj@wu.ac.at

thomas.grisold@wu.ac.at

roman.walser@wu.ac.at

Abstract: Innovation processes require organizations to transcend current boundaries. These include not only technological as well as social limitations but -above all- the way we address the future. We are used to face the future with our existing knowledge and experiences from the past. This strategy, however, can hardly lead to knowledge off the beaten path. We therefore suggest a new learning approach for organizations, which enables to literally envision a desired future scenario and thereby, allows for the creation of radical new knowledge. We argue that the created knowledge yields a higher degree of novelty and radicalness. Along with an enhanced theory of learning including learning from the future, we present our empirical findings from comparing the outputs of *Learning from an Envisioned Future* and learning from the past. For this purpose, we use data from two organizational learning projects; one, which was conducted with a high school in Austria and another one, which was conducted with members of the Austrian Economic Chamber. Our findings from both case studies suggest that *Learning from an Envisioned Future* does produce significantly more paradigm challenging knowledge compared to the output gained from conventional learning from past experiences. We conclude that the combination of both learning sources may lead to best learning outcomes in organizations.

Keywords: organizational learning, learning from an envisioned future, knowledge management, multi-case study, learning modes

1. Introduction

It is generally assumed that companies have to continuously progress in order to gain competitive advantage and to be able to innovate. Accordingly, an organization is seen as a dynamic entity (Nonaka, Toyama, & Nagata, 2000), which creates knowledge in order to cope with its changing environment. A common approach to innovate is to apply well-proven solutions to new contexts. Thereby, we may enable incremental innovations that include new aspects but are restricted by the past (e.g. by experienced limitations, cognitive boundaries etc.); they tend to share common features and are “more of the same”.

We suggest an additional type of learning which yields the potential to overcome these limitations; we argue that by shifting our attention towards an ideal future scenario we enable the creation of knowledge, which is less biased by our experiences from the past. We label this method *Learning from Interacting with an Envisioned Future*, in short *Learning from an Envisioned Future* (Kaiser, Fordinal, & Kragulj, 2014; Kragulj, 2014a, 2014b). Thereby, subjects are guided into an envisioned future scenario where they create knowledge. We assume that the outcome of our method differs from conventional learning modes, both in terms of quality and quantity. However, this has rarely been tested empirically and will be the subject of this paper (Kaiser, Kragulj, Grisold, & Walser, 2015a).

In the following section, we will outline the theoretical background of *Learning from Interacting with an Envisioned Future*, in short *Learning from an Envisioned Future*, to then present our findings from two empirical studies where we contrasted learning from the past with learning from the future. Finally, we will discuss the result and provide a conclusion along with implications for practical implication.

2. Theoretical background

2.1 Research on learning – where is the future?

What is learning? Albeit defined by many authors in slightly different ways, conventional experiential learning theory defines learning as “the process whereby knowledge is created through the transformation of experience. Knowledge results from the combination of grasping and transforming experience” (Kolb, 1984, p. 41). Thereby, learning is defined as an action-reflection process based on reflecting experiences from the past, i.e. experiences are acquired in the past and by processing these experiences, we adjust our behaviour to meet later demands. A popular illustration may be a child who, after burning her hand by touching a hot stove, has learnt not to touch the hotplate again. The concept of learning from the past is well developed and underlies all major learning methodologies, best practices and

approaches to organizational learning. There are several learning theories, which are all based on the paradigm of learning from past experiences (Argyris & Schön, 1978, 1996), (Kolb, 1984), (Kolb & Kolb, 2005), (Bateson, 1972).

However, this conventional conception of learning heavily rests on the assumption that what we learn is always dependent on success or failures that have been made in the past, i.e. all behaviour is anchored in a previous point of time. Psychologist Seligman and colleagues point out that the idea of such a “driven by the past-framework” has been dominant in the research on cognition-related topics, such as learning (Seligman, Railton, Baumeister, & Sripada, 2013, p. 120). The authors draw attention to a lack of considering prospectation - i.e. the ability to represent possible future states that have never occurred – in theories on human cognition (ibid.), even though this feature is central and unique to humans (Roberts, 2002). They reason that this lack may be due to the supremacy of behaviourism in psychology and learning theory, where behaviour was thought to be determined by the organism’s past while mental events (such as prospectation) were strictly excluded “in favour of drives and habits” (p. 121).

While “learning and memory necessarily reflect past experiences” (Seligman et al., 2013, p. 120), psychology should also focus on an organism’s capability to anticipate and act in view of possible future states; the authors intend the idea that “intelligent action is guided by assessment of future possibilities rather than driven by the past” (p. 129).

In line with Seligman and colleagues, we want to emphasize that conceptualizing learning, as being solely rooted in past experiences, may be only one side of the coin; rather, past experiences should be understood as a basis to *selectively* extract information and behaviour based on goals or needs in the future (Seligman et al., 2013, p. 119). Hence, the imagination of future states shall serve as an additional source of learning and past experiences.

There is a strong demand for a future-related learning approach in the field of knowledge management; here, experiences from the past are often referred to as constraints for successful future behaviour (Tsang & Zahra, 2008). Nonaka highlights that “companies have to create new futures in order to survive. Those features can no longer be extensions of the past; they must be leaps of faith into the tomorrow” (Nonaka & Takeuchi, 2011, p. 67). Scharmer takes a step further and calls for “learning from the future as it emerges” to transcend the boundaries of what we are used to know and think in order to facilitate the creation of new knowledge (Claus Otto Scharmer, 2001). In a similar vein, Buchen (1999) suggests that in order to move beyond “incrementalism”, i.e. the repetitive use of well-known strategies and thinking patterns, we must shift the attention to anticipating and learning from future states (Buchen, 1999, p. 121).

An alternative kind of learning may be of particular interest for the research on innovation as it may help us to understand how *radical* innovations occur. The conventional idea of learning from past experiences may explain how incremental innovations occur as they are seen as “extensions to current product offerings or logical and relatively minor extensions to existing processes” (McDermott & O’Conner, 2002, p. 424). However, it remains puzzling how radical innovations can be achieved, as they are “new technologies or ideas into markets that are either non-existent or require dramatic behaviour changes to existing markets” (ibid). Radical innovations cannot be extrapolations of past experiences and thus, they constitute a radical rupture with the conventional view of learning.

The inclusion of future states has been happening in different research areas, such as rationality (Kahneman, 2011), empathy and emotion (Gilbert, D. T., Wilson, 2000) or psychotherapy (cf. “future-directed therapy”, Vilhauer et al. (2012)). Surprisingly, it has only been vaguely considered in learning theory even though it has been found that remembering the past and imagining the future rely on the same cognitive resources; both episodic memory and prospective simulation share cortical substrates and common process, such as “the storage and recall of individual details, mental imagery, and self-referential processing”. Additionally, “both involve constructive operations that bring together these elements in a coherent mode” (Schacter & Addis, 2007; Seligman et al., 2013, p. 129; Szpunar, 2010).

By merging both sources, our idea of “Learning from an Envisioned Future” may be an approach to fill the gap, as it adds an additional future-related learning source. It seems especially interesting to scholars and practitioners in the field of knowledge management as it suggests to getting rid of past experiences and thereby, to facilitate the creation of (radically) new knowledge (Buchen, 1999; Seligman et al., 2013; Tsang & Zahra, 2008).

2.2 Learning from an envisioned future

Inspired by Scharmer's *Learning from the Future*, we developed a methodological framework, which takes the approach of learning from the future to a literal use. Our method of *Learning from Interacting with an Envisioned Future*, in short *Learning from an Envisioned Future*, embraces the imagination and the actual interaction with a

desired future scenario. (Kaiser et al., 2014; Kragulj, 2014a) Essentially, the method calls for projecting ourselves forward in time and to pre-experience a world, which we construct mentally (Atance & O'Neill, 2001). By doing so, we generate knowledge from the experience we make in our imaginary environment in the absence of actual sensory experience, by guiding subcortical structures in situations where they respond as if to actual sensory experience (Gilbert, D. T., Wilson, 2007; Seligman et al., 2013; Szpunar, 2010). By developing a goal worth striving for and by identifying actions to reach this goal from the present situation, we add an a-priori teleological dimension (i.e. we introduce a goal before the learning process initiates), which appears essential for successful future learning (Seligman et al., 2013). This teleological dimension forms a crucial difference between our Learning from Envisioned Future and Scharmer's idea of Learning from the Future. While we explicitly encourage subjects to construct goals to then find out how they can reach these goals, Scharmer proposes to shift attention towards the individual's inner world, to accept the pure experience and to sense the very moment by "connecting with the source of one's best future possibility and of bringing this possibility into the now" (C. Otto Scharmer & Kaeufer, 2010, p. 25f); what wants to emerge, however remains unclear until it has been embodied in manifest experience (Claus Otto Scharmer, 2000).

The methodological procedure for our approach looks as follows: in a workshop or interview setting, we encourage participants to imagine and report from an ideal future scenario. Participants should fully immerse into their imagination, which contains the desired state of the respective social system from their point of view (e.g. the ideal school in the future from the perspective of a teacher working there). From "there", the participants should narrate as if they already interacted with their envisioned future environment – how does it look like; how does it feel to be "there"? We facilitate the process of "time travelling" by providing an enabling space (Peschl & Fundneider, 2014), using rituals like music and change of physical gesture (e.g. changing the sitting position when "reaching" one's ideal future scenario).

Our method aims to facilitate the detachment from today's circumstances, including restrictions, boundaries and impossibilities experienced in the past. We want to enable people to come up with visionary and creative results transcending the current state of affairs and leaving behind the "dirty work of the past" (Seligman et al., 2013, p. 134).

By learning from an envisioned future, we can mentally create images of solutions and scenarios that seem unrealistic with respect to any given circumstances including social, economic or technical limitations, but are nevertheless attractive to us, i.e. they may please us and meet our needs (Goffin, Lemke, & Ursula, 2010). Thereby, we can model our own desired future and subsequently align our actions in order to bring our imagination to life.

Furthermore, learning from an envisioned remote future may facilitate the articulation of more intrinsic thoughts as "a more distal time perspective shifts attention inwards, towards the core and most defining characteristics of the person, activating the ideal self" (also see Boyatzis & Akrivou, 2006; Kivetz & Tyler, 2007, p. 196).

In the following section, we introduce an enhanced theory of learning, including learning from the future, to show that our approach may be a well-fitting extension to theoretical consideration about learning.

2.3 An enhanced theory of learning including learning from the future

In (Kaiser, 2016) our enhanced theory of learning has been described in detail. In this paper we will provide a brief outline of the most crucial aspects of our theory. Our suggested theory is based on the learning theory by Gregory Bateson (Bateson, 1972). He proposed several levels of learning. In the following, we use Bateson's learning theory (without taking into account Learning 0) as a basis for conceptualizing a coherent theoretical framework that integrates both learning from the past and learning from the future. In a first step, we will present Bateson's three different levels of learning in a more formalized way. For this we define the following domains/sets, which are relevant at each level of learning:

A:	set of (action) alternatives
G:	set of goals
R:	result (outcome, output) of a learning process
○ U:	○ set of underlying values, needs, assumptions, beliefs – "the underlying mental model"

Using these domains, we can define Bateson's levels of learning Learning-1, Learning-2 and Learning-3 as follows.

Learning-1 (L-1): L-1 is described as change within a set of alternatives (Bateson, 1972). It involves optimizing the choices of alternatives taken out of A . This learning and optimization is based on experiences from the past, driven by the elements of U and controlled via the goal G and the resulting outcome R , by taking the selected alternatives A' out of A , where $A' \subseteq A$. In short, L-1 leads to knowledge about the optimal choice of alternatives out of a static set of (action) alternatives.

Learning-2 (L-2): L-2 is described as change in the set of alternatives (Bateson, 1972). So in L-2, the set of (action) alternatives becomes dynamical. This change in the set of alternatives is based on experiences from the past driven by the elements of U and controlled via the goal G and the resulting outcome R , by taking the selected alternatives out of $A+$. As L-2 is a change in the set of alternatives, $A+$ refers to the changed set. We can define that $A+ \neq A$. The main learning outcome of L-2 is knowledge about the changed set of alternatives along with knowledge about the new action alternatives, i.e. all elements of $A+$, which have not been elements of A . Methods like case based reasoning or forecasting enable L-2.

Learning-3 (L-3): L-3 is described as a corrective change in the system of sets of alternatives from which a choice is made (Bateson, 1972). So while L-1 optimizes the choice of alternatives out of a static set of action alternatives (A) and L-2 changes the set of action alternatives (A) and creates $A+$, the main focus of L-3 is U , which is the set of underlying needs, values, etc. – summarized as “mind set”. While Bateson points out that L-3 rarely if ever occurs, we propose that L-3 certainly is a very challenging learning mode but nevertheless it may occur more often than not.

Remember that U mainly drives L-1 as well as L-2 and determines A as well as $A+$. U is a rather complex construct. In our approach, we propose that the current set of U is determined by two influencing variables:

- an internal motivated part UI and
- an external motivated part UE

UI furthermore can be split into a conscious part UIC and an unconscious part UIU . Needs, values or aspirations which I am aware of are examples for UIC , e.g. the aspiration of earning a lot of money or the need of receiving a lot of compliments; needs and values which I am currently not aware of are examples for UIU , e.g. the need for safety in different forms which strongly influences a lot of my actions but I wouldn't be able to articulate it. Examples for UE are expectations of others, general valid values and rules or widely acknowledged knowledge.

At this point, it must be emphasized that L-3 changes the current set of U and this change is based on experiences from the past. The main learning outcome of L-3 is threefold:

- Creation of knowledge, which elements of UIC are currently strongly action driving when selecting alternatives and which other elements of UIC are – currently – more in the background. Hence, the externalization of the elements of UIC and the roles they are playing at any given moment are one crucial aspect of L-3;
- Becoming aware and making explicit the elements of UIU – as far as possible – is another learning outcome of L-3. L-3 is strongly connected with reflection work, may it occur in a therapeutical setting (psychotherapy, etc.) or in a consulting/counselling oriented setting (coaching, supervision, mediation, etc.) on an individual level as well as on an organizational level (group coaching, group supervision, etc.). Furthermore, L-3 can be seen as a learning mode for becoming aware of some main components of the ideal self (Boyatzis & Akrivou, 2006) ;
- Knowledge is gained by focusing on the set of UE . This essentially means to consider consequences for those entities which are involved by the action alternatives (A). This third learning outcome is strongly connected with the aspects of phronesis (Nonaka & Toyama, 2007) or common good and with the whole field of sustainability.

All three learning outcomes together change the set of U to an updated current set $U_{mod.}$.

In a second step, we will enhance the described learning theory consisting of those three levels of learning by adding an alternative source of learning along with three additional levels of learning. Based on the idea of *Learning from an Envisioned Future*, which embraces the imagination and the actual interaction with a desired future scenario, we are able to define Future-Learning-1, Future-Learning-2 and Future-Learning-3.

Future-Learning-1 (FL-1): FL-1 can be defined as a change within a set of alternatives based on experiences from an envisioned future. It refers to optimizing the choices of alternatives taken out of A . This learning and optimization is based on experiences from the envisioned future F determined by G . It is driven by the elements of U and controlled via a backcasting approach beginning in the envisioned future and ending in the presence based on which the selected alternatives A_F' out of A are identified, where $A_F' \subseteq A$. FL-1 leads to knowledge about an optimal choice of alternatives out of a static set of action alternatives.

Future-Learning-2 (FL-2): FL-2 can be defined as change in the set of alternatives based on experiences from an envisioned future. So in FL-2, the set of (action) alternatives becomes dynamical.

This change in the set of alternatives is based on experiences from the envisioned future F determined by G , driven by the elements of U and controlled via a backcasting approach beginning in the envisioned future and ending in the presence. As FL-2 is a change in the set of alternatives, it creates A_{F+} , where A_{F+} denotes the changed set of alternatives. Therefore, we can define that $A_{F+} \neq A$. The main learning outcome of L-2 is knowledge about the changed set of alternatives, i.e. knowledge about new action alternatives, more specifically those elements of $A+$ which have not been elements of A .

Future-Learning-3 (FL-3): FL-3 can be defined as a corrective change in the system of sets of alternatives from which a choice is made based on experiences made in an envisioned future. Accordingly, FL-3 changes the current set of U . This change in the current set of U is based on experiences from an envisioned future determined by G , and controlled by an abductive reasoning process. Abductive inference may help us to construct an intentional explanation through motives (reasons) that makes the behavior tangible. It is the only logical operation which introduces any new idea (Fischer, 2001).

The main learning outcome of FL-3 is threefold:

- Creation of knowledge, which elements of U are substantial for me in the long run;
- Transcending existing boundaries by envisioning the future enables the creation of knowledge of how to serve the common good. This high-quality knowledge is described as phronesis (Nonaka & Toyama, 2007). Phronesis takes into account contextual circumstances, addresses particulars, and shifts aims in process when necessary and is guided by values and ethics.
- Identifying and creation of knowledge about hidden needs (Goffin et al., 2010) is another learning outcome of FL-3. Hidden needs are defined as requirements that customers or users have but which they have not yet directly recognized. As these requirements rest on a subconscious level, users are unable to articulate them (Goffin et al., 2010). So, hidden needs are strongly connected with UIU in our theory (Kaiser, Kragulj, Grisold, & Walser, 2015b).

All three learning outcomes together change the set of U to an updated current set U_{mod} .

Relationships between the six learning modes

Analyzing those six learning modes, we can see that G plays an important role in this learning theory.

On the one hand, in the case of learning based on the experiences from the past, G determines R in L-1 and L-2 and enables as well as creates the experiences from the past, which are essential for the learning modes L-1, L-2 and L-3. Hence, G also influences $A+$ and A' which are the main output of L-1 and L-2. On the other hand, G is an important driver for the envisioned future F in the case of FL-1, FL-2 and FL-3. G itself is determined by U , (respectively UIC , UIU and UE) which is changed by L-3 as well as FL-3, and so the twofold learning cycle is complete. Figure 1 depicts this twofold learning cycle.

The set of U is changed by L-3 and FL-3 as well and therefore it determines and may possibly change the goal G to a modified goal G_{mod} . Assuming that G_{mod} could be the starting point for the subsequent learning cycle, this learning theory describes a recursive and iterative process of holistic learning.

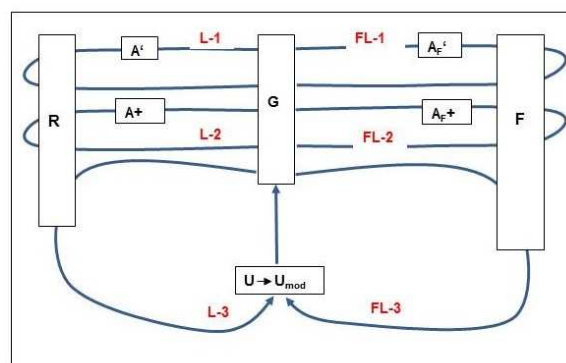

Figure-1: twofold learning cycle

Now let us have a look at the relation between G and R and the relation between G and F . The result R is the concrete output by taking actions in order to achieve the goal G , whereas F is the consequence of a fulfilled goal, without taking into account in which way it has been reached. Therefore, we can compare R and G and describe respectively “measure” the differences between them. This measurement constitutes experiences which are more oriented towards the past. F gives a good orientation and description of what it actually looks and feels like when G has been reached. So F is some kind of corrective whether G is a “good and correct goal” and it constitutes experiences which are more future-oriented.

In short, we have **two kinds of experiences**, which determine the learning outcome and are responsible for the continuous change and development of U as well as G and A .

3. Research gap, research question and research methodology

The bulk of empirical studies focusing on the output of learning processes are based on the conventional learning paradigm, i.e. learning from past experiences (e.g. Engeström & Sannino, 2010; Goh, 2003; Issenberg, McGaghie, Petrusa, Lee Gordon, & Scalese, 2005; McEneaney, 1990; Mishra, 2001; Simonin, 1997; Smits, Verbeek, & de Buissonje, 2002). Although we do notice an increasing relevance and popularity in the approach of learning from the future in literature and practice (Jaworski & Scharmer, 2000; Kaiser et al., 2014, 2015b; C. Otto Scharmer & Kaeufer, 2010, 2013; Claus Otto Scharmer, 2007; Szpunar, 2010), there is a lack of empirical studies exploring the output of this learning approach. There are no empirical studies, which compare the output of learning based on past experiences with the output of learning from the future.

Based on this research gap, the main purpose of our paper is to investigate the output of learning from the future empirically. Accordingly, the research question is: “How does the use of Learning from Interacting with an Envisioned Future as an additional learning mode support the quality and quantity of innovative ideas?”

In line with the definition of Yin (1994) and (Eisenhardt & Graebner, 2007), we use empirical data from two distinct projects to conduct a multi-case study. The two case studies differ in terms of their domains, persons involved (age, role, professional background), goals and structures. In both cases, we used and compared the same learning approaches, namely the traditional learning approach based on the past and Learning from an Envisioned Future as a future-related learning source. Thus, the results of both case studies are comparable in terms the genesis of data. As a result, we gained a rich set of empirical data incorporating two perspectives on the focal phenomenon (learning source), which we evaluated with regards to their creative potential.

Generally speaking, research on creativity and innovation shows that the assessment of output can be done with respect to different paradigms and evaluation procedures (Dean, Hender, & Rodgers, 2006; Piffer, 2012). We decided to analyze the collected output of both groups using the *Paradigm Relatedness Framework*. It allows for evaluating the novelty of an idea with regards to the status-quo of a particular system (cf. Dean et al., 2006; Nagasundram & Bostrom, 1994). Compared to other methods to measure creativity, the Paradigm Relatedness Framework allows for assessing novelty without having a *specific* problem context or goal that should be resolved with an idea; in our cases, (1) pupils were free to come up with whatever they found most desirable in their ideal school settings and (2) members of the Austrian Economic Chamber could fantasize about how ideal future states could be met.

The framework by Nagasundram & Bostrom (1994) depicting the relationship between elements and relationships between elements is shown in Figure 2.

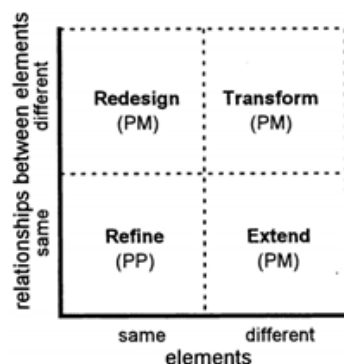

Figure 2: Analyzing paradigm-relatedness (Nagasundram & Bostrom, 1994, p. 94).

According to the *Paradigm Relatedness Framework*, the novelty of an output can be evaluated and classified as being either paradigm-preserving (i.e. an adaptation to the current conditions in a system) or paradigm-modifying (i.e. a modification of the current conditions in a system). Thereon, output can belong to one of *four categories*:

- Category 1 (Refine): Ideas are paradigm-preserving when they refine a system or a problem context.
- Category 2 (Extend): Ideas are paradigm-modifying when they change the system by adding a new element to the context.
- Category 3 (Redesign): Ideas are paradigm-modifying when they alter the relationship between elements of a system.
- Category 4 (Transform): Ideas are paradigm-modifying when they both add a new element as well as change the relationship of the elements.

In order to investigate the degree of novelty and radical change for the respective learning modes, we approached both case studies in the same way. In both cases, we randomized the collected data of both learning sources to remove any bias with regards to which learning source they came from. Subsequently, by going through all items we assessed each item for its creative potential by assigning one of the four categories suggested by the Paradigm Relatedness Framework. Finally, we merged the complete data for each case study and analyzed the overall output of each learning source in terms of quality and quantity. A detailed description for each case will be presented in the following section.

4. Case studies

Both case studies were organizational learning processes in different domains with different scopes (change management and strategy development).

Case study 1 was conducted in a high school with pupils in the age of 17 – 18 years. The intended outcome of the learning process was to describe an ideal situation of the high school, which potentially satisfies the pupils' needs. We refer to these describing statements as *satisfiers*, indicating one of many ways to potentially satisfy a need.

Case study 2 was conducted with the Austrian Economic Chamber (WKO). Around 50 official representatives participated in two workshops which were held to define concrete actions to realize four pre-defined long-term goals. Instead of describing satisfying states of affairs (which were already represented by the pre-defined goals), the guiding question in this project was what concrete actions could be taken WKO and politics to accomplish the goals.

Case study 1 strived for answering a “*what*” question, i.e. *what* satisfies pupil's needs in the particular high school, resulting in a description of an ideal state of affairs. In case study 2, participants elaborated on a “*how*” question, i.e. *how* could members of the WKO reach the pre-defined goals, resulting in a definition of concrete actions that can be taken.

4.1 Case study 1

The first case study was part of a large organizational learning project with 400 participants in a high school in Lower Austria, where we applied our methodological framework *Bewextra*. In short, the overall goal of *Bewextra* is to externalize knowledge about people's needs in a social system. In doing so, we differentiate between *satisfiers* (i.e. concrete solutions and products) and underlying *needs* (i.e. normatively important urges that themselves do not specify a concrete satisfier). (for further information on this framework, see e.g. Kaiser & Kragulj (2016)). We will now focus on the first step of the method, where we ask subjects to name a variety of concrete satisfiers. Here, we contrasted the satisfiers resulting from Learning from an Envisioned Future with the satisfiers resulting from the conventional learning from past experiences.

The case study was conducted in 2014 with pupils and a few teachers of two high school classes. They took part in two data acquisition workshops, i.e. we hosted one workshop for each class. All pupils were about the same age (17-18 years). In total, a number of 31 pupils and teachers participated in the study, where 12 pupils and 2 teachers were learning from their envisioned future (workshop 1), and 17 pupils learned from past experiences (workshop 2).

In workshop 1, we used our method Learning from an Envisioned Future. In workshop 2, the pupils were asked to think of their ideal future scenario while taking into account their past experiences. The participants of workshop 1 answered the following questions: (a) “What has emerged and is new?”, (b) “what has come to an end?”; in workshop 2: (a) “What will have had emerged and is new?”, (b) “what will have had come to an end?” So according to our

proposed enhanced theory of learning, in workshop 1 the participants primarily used the learning mode FL-2 and also FL-1, while in workshop 2, the primary learning modes were L2- and also L-1.

4.1.1 Analysis

In workshop 1, participants generated a total number of 369 satisfiers and in workshop 2, the participants generated a total number of 520 satisfiers. A team of four researchers analyzed the two data sets. The collected satisfiers were transcribed and randomized; any hint for whether they come from workshop 1 or workshop 2 had been effaced. Thereby, it was ensured to remain unbiased during the analysis. The procedure consisted of three steps. First, a subset of about 200 satisfiers was analyzed together in four in order to get a common understanding of how to approach the data. Second, the remaining satisfiers were distributed among the four researchers for individual analysis; this allowed for an efficient process and reduced a potential group-bias. In a third step, all satisfiers were jointly re-assessed and checked for intersubjective consistency.

We analyzed the satisfiers with two respects. First, we clustered the output according to abstract domains that emerged in the data sets. These domains were refined over several iterations. Thereby, we added structure to the high number of collected answers and facilitated a consistent assessment of the satisfiers. Second, we assessed each satisfier in terms of its creative potential according to the Paradigm Relatedness Framework. The following two examples are from the data set and illustrate how we assessed the items of different domains using the Paradigm Relatedness Framework as previously described in section 3.

Example A (domain: curriculum design): suggestions for a future curriculum design were:

- Category 1: Better explanations by teachers (refining current situation)
- Category 2: New teaching methods (new element into system)
- Category 3: Curriculum is organized as a flexible module system (relationship between existing elements)
- Category 4: No attendance at all, pupils can attend school via Skype (changed relationship of the elements and adding a new element).

Example B (domain: support of talent/strength): suggestions for future support of skills and talents were:

- Category 1: Generally more focus on recognizing and enhancing talents (refining current situation)
- Category 2: Offer of special course to support strengths (new element into the system)
- Category 3: Pupils are individually supported (changing relationship between existing elements, i.e. teachers and pupils)
- Category 4: Individual support of talents with special campaigns, e.g. sending them to universities (changing relationship of the elements and adding a new element)

4.1.2 Results

The key figures of case study 1 are summarized in Table 1.

	Workshop 1 (Learning from an Envisioned Future)	Workshop 2 (Conventional learning from the past)
Number of participants	14 (12 pupils + 2 teachers)	17 pupils
Number of satisfiers	369	520
(Avg.) satisfiers per participant	26	31
Covered domains	61	59

Table 1: Key figures of case study 1

Figure 3 shows the number of different domains to which the generated satisfiers were assigned. Overall, we identified 70 different domains. 50 of them were represented in both workshops by at least one satisfier. The pupils participating in workshop 2 came up with 9 additional and unique domains whereas workshop 1 delivered 11 unique domains.

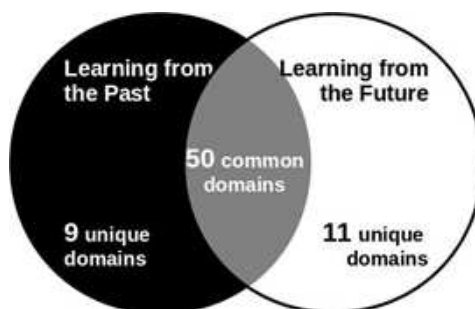

Figure 3: Common and unique domains of satisfiers produced in the respective learning mode

Furthermore, by comparing the respective outcome using the Paradigm Relatedness Framework, we can see in Figure 4 that Learning from an Envisioned Future generates almost 90% of all satisfiers that are ascribed to category 4 (i.e. containing the suggestions that are most paradigm-challenging and radical new for the system). Similarly, Learning from an Envisioned Future facilitated the creation of category 3-satisfiers, as it is evident with about 75%.

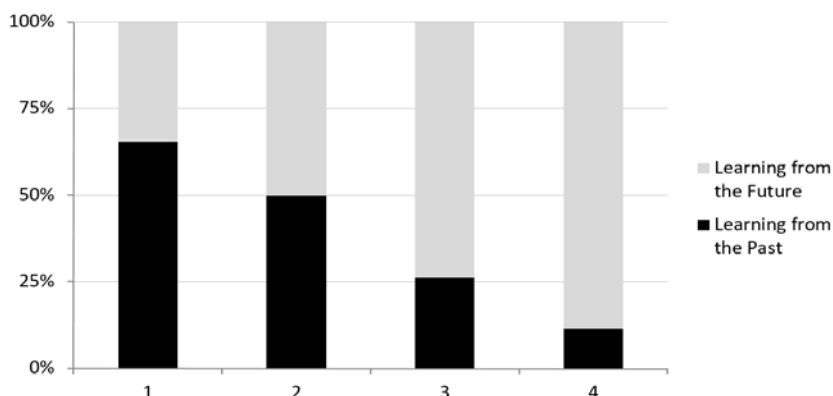

Figure 4: Composition of each category of paradigm-relatedness framework with regards to the learning mode

4.2 Case Study 2

The second case study was a strategy developing process we conducted with the Austrian Economic Chamber (WKO). The process was framed by four long-term goals pre-defined by WKO’s management. The project’s objective was to collaboratively create a goal-directed strategy for the industry sector Crafts and Trades with a time scope reaching into the year 2020. The project’s intended outcome was to develop a widespread catalogue of concrete actions to reach the four pre-defined goals.

Similar to case study 1, we conducted two workshops where we used the learning modes respectively. Around 50 officials participated in both workshops.

For the purpose of this project and the subsequent analysis, a clear distinction between concrete actions and vague requests has been drawn. A statement has been identified to be an action when it concretely describes *what entity* shall be changed *in what way*. This action may be unrealizable under given circumstances, however, due to its concrete wording, it has to be conceivable in a way that members of the WKO would actually know *how* to actually take the action.

In both workshops, participants collectively developed concrete actions. Workshop 1 was led by a professional facilitator (not part of the researcher team) who facilitated a traditional past-oriented learning approach. 16 officials developed 79 statements of which 41 (52 %) were classified as actions. According to our proposed enhanced theory of learning, in this workshop learning mode L-2 has been primarily used complemented with learning mode L-1.

In workshop 2, 34 participants developed actions using Learning from an Envisioned Future as a learning source. They worked in four groups, where each group thought of actions to reach one of the four pre-defined goals. The participants generated 237 statements of which 62 (26 %) were classified as actions. In accordance with our enhanced theory of learning, mainly learning mode FL-2 has been used in addition with FL-1.

4.2.1 Analysis

The analysis of this case study resembled the analysis of case study 2. The classification of statements as actions (workshop 1: 52 %; workshop 2: 26 %) was done irrespectively of their origin (items of both workshops were randomized and any hint for which learning mode they came from had been effaced). In a next step, we categorized all actions into domains. Finally, we analysed all items using the Paradigm Relatedness Framework.

4.2.2 Results

The key figures of our case study are summarized in Table 2.

Table 2: Key figures of case study 2

	Workshop 1 (Conventional learning from the past)	Workshop 2 (Learning from an Envisioned Future)
Number of participants	16	34
Number of statements	70	237
Number of actions (cleared up)	41	62
(Avg.) actions per participant	2.56	1.82
Covered domains	7	7

The 103 items, which were identified as actions, covered 8 domains. 6 domains were addressed in both workshops. One domain was almost exclusively covered by the first (past-oriented) workshop whereas one domain was covered by the second (future-oriented) workshop. Thus, conducting two workshops using both learning approaches led to an increase of 14.3 % with regards to the number of domains that were covered by the actions.

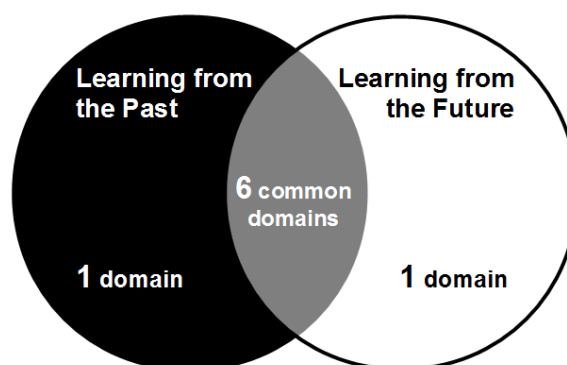

Figure 5: Common and unique domains of actions produced by the respective learning mode

Using the Paradigm Relatedness Framework, the analysis reveals results similar to those of the first case study. Figure 6 shows that a significant majority of the actions that were found to belong to category 4, i.e. the most paradigm-challenging, originate from Learning from an Envisioned Future, as it is evident with 86%. On the contrary, actions that were found during the past-oriented workshop make up almost two thirds of group 1, the least radical and possibly least innovative category. It has to be stated that workshop 2 produced more actions than workshop 1, which may be due to the higher number of participants in workshop 1. However, the distributions in category 2 and category 3 confirm the trend that the future oriented workshop results in more status-quo challenging actions.

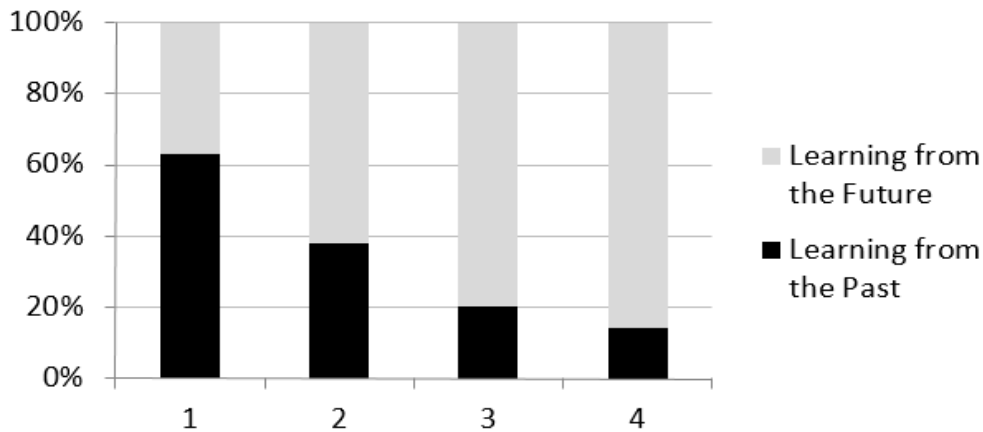

Figure 6: Distribution of the four categories of the paradigm relatedness framework that were produced in the respective learning modes

4.3 A comparison of the main outcomes of the two cases

Figure 6 shows the distribution of the categories for both workshops separately. The results indicate that Learning from an Envisioned Future supports the generation of paradigm-challenging action (i.e. actions that belong to categories 2, 3 and 4). Overall, the output of the past-oriented workshop was paradigm preserving with a rate of 53 %. On the other side, only 20 % of the actions of the future-oriented workshop refer to existing paradigms. These results are in line with the findings from case study 1.

Following our research question and comparing the outputs of both case studies, we can observe differences of both learning sources in terms of quality and quantity.

Firstly, Learning from an Envisioned Future generates output that is more challenging to the status-quo of a social system and yields a higher degree of novelty. On the contrary, the conventional learning from past experiences produces a considerably higher number of satisfiers that are paradigm preserving, i.e. that refine the current state of the system. Therefore, there is an overall tendency for providing more moderate and less novel ideas in a conventional learning based on past experiences. These results indicate that Learning from an Envisioned Features tends to facilitate the generation of paradigm-modifying output (i.e. satisfiers assigned to categories 2, 3 and 4). Figure 7 comparatively illustrates the distribution of the categories for the respective learning modes.

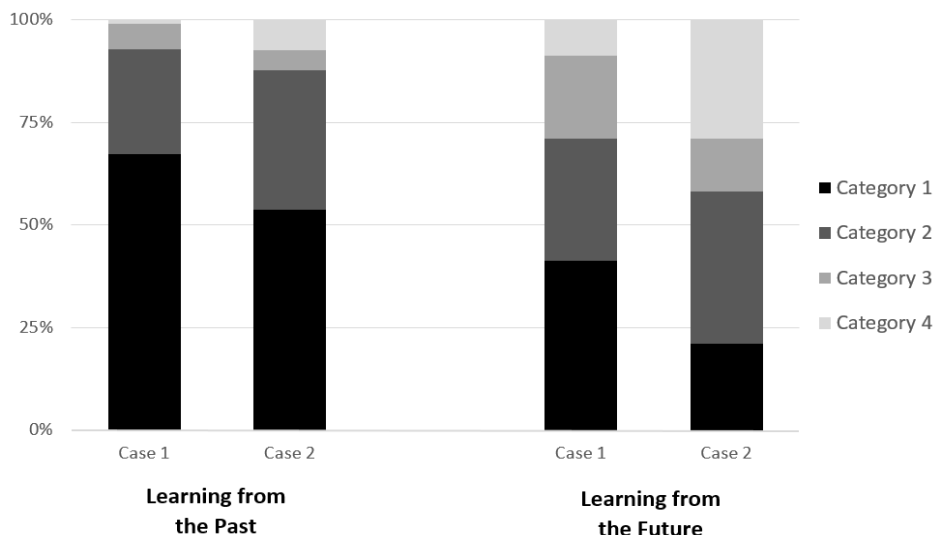

Figure 7: Comparison: distribution of the four categories of the paradigm relatedness framework produced in the respective learning mode

Secondly, by combining both learning approaches, the number of overall covered domains increases considerably (case 1: + 18.7 %; case 2: + 14.3 % compared to learning from the past only). Although the number of different

domains should not be taken as a guarantee for a higher quality per se, we can reason that a more diverse output provides an additional valuable scope for action. Furthermore, it increases the possibility that less obvious but possibly important topics are revealed.

5. Conclusion and implications

Our analysis of two different cases provides three main findings.

Firstly, it demonstrates that Learning from an Envisioned Future yields the potential for being an additional learning mode as it most likely enables the creation of creative and innovative solutions.

Secondly, our case studies show that the combination of learning based on experiences from the past with Learning from an Envisioned Future leads to a higher number of innovative ideas, both in terms of quality and quantity. The results suggest that an optimal learning strategy is not about deciding to either learn from the past or from the future, but to use both modes complementarily. The results of the case studies illustrate that combining both learning modes increases the number of domains covered in the learning processes.

Finally, there is solid evidence that these findings hold for diverse domains and even for different intended learning outcomes.

As a result, this research has important implications for practice. Utilize alternative learning modes like Learning from an Envisioned Future fosters innovative and sustainable solutions, irrespective of the field in which they are applied.

References

- Argyris, C., & Schön, D. A. (1978). *Organizational Learning: A Theory of Action Perspective*. Reading, Massachusetts: Addison-Wesley Publishing Company.
- Argyris, C., & Schön, D. A. (1996). *Organizational Learning II*. Reading, Massachusetts: Addison-Wesley Publishing Company.
- Atance, C. M., & O'Neill, D. K. (2001). Episodic future thinking. *Trends in Cognitive Sciences*, 5(12), 533–539.
- Bateson, G. (1972). *Steps to an ecology of mind: Collected essays in anthropology, psychiatry, evolution, and epistemology*. University of Chicago Press.
- Boyatzis, R. E., & Akrivou, K. (2006). The ideal self as the driver of intentional change. *Journal of Management Development*, 25(7), 624–642.
- Buchen, I. H. (1999). Creating the future: innovation and the unlearning organization. *Foresight*, 1(2), 117–123.
- Dean, D. L., Hender, J. M., & Rodgers, T. L. (2006). Identifying Quality, Novel, and Creative Ideas: Constructs and Scales for Idea Evaluation. *Journal of the Association for Information Systems*, 7(10), 646–699.
- Eisenhardt, K. M., & Graebner, M. E. (2007). Theory Building From Cases: Opportunities and Challenges. *Academy of Management Journal*, 50(1), 25–32.
- Engeström, Y., & Sannino, A. (2010). Studies of expansive learning: Foundations, findings and future challenges. *Educational Research Review*, 5(1), 1–24.
- Fischer, H. R. (2001). Abductive Reasoning as a Way of Worldmaking. *Foundations of Science*, 6(4), 361–383.
- Gilbert, D. T., Wilson, T. D. (2000). Miswanting: Some Problems in the Forecasting of Future Affective States. In J. P. Forgas (Ed.), *Thinking and feeling: The role of affect in social cognition* (pp. 178–197). Cambridge: Cambridge University Press.
- Gilbert, D. T., Wilson, T. D. (2007). Propection: Experiencing the Future. *Science*, 317(September), 1351–1354.
- Goffin, K., Lemke, F., & Ursula, K. (2010). *Identifying hidden needs: creating breakthrough products*. Palgrave Macmillan.
- Goh, S. C. (2003). Improving organizational learning capability: lessons from two case studies. *The Learning Organization*.
- Issenberg, S. B., McGaghie, W. C., Petrusa, E. R., Lee Gordon, D., & Scalese, R. J. (2005). Features and uses of high-fidelity medical simulations that lead to effective learning: a BEME systematic review. *Medical Teacher*, 27(1), 10–28.
- Jaworski, J., & Scharmer, C. O. (2000). *Leadership in the New Economy: Sensing and Actualizing Emerging Futures*. Cambridge, Generon.
- Kahneman, D. (2011). *Thinking, Fast and Slow*. Macmillan.
- Kaiser, A. (2016). An enhanced theory of learning including learning from the future. In System Sciences (HICSS), 2016, 49th Hawaii International Conference on System Science (pp. 4303–4312). IEEE.
- Kaiser, A., Fordinal, B., & Kragulj, F. (2014). Creation of Need Knowledge in Organizations: An Abductive Framework. In System Sciences (HICSS), 2014, 47th Hawaii International Conference on System Science (pp. 3499–3508).
- Kaiser, A., & Kragulj, F. (2016). Bewextra: Creating and Inferring Explicit Knowledge of Needs. *Futures Studies*, (accepted for publication).
- Kaiser, A., Kragulj, F., Grisold, T., & Walser, R. J. (2015a). Extending the Organizational Learning Process in Order to Enable Innovative Ideas. In *Proceedings of the ECKM-2015 (16th European Conference on Knowledge Management)* (pp. 391–398).
- Kaiser, A., Kragulj, F., Grisold, T., & Walser, R. J. (2015b). Identifying Hidden Needs by Enhancing Organizational Learning. In V. Ribière & L. Worasinchai (Eds.), *Proceedings of the ICICKM-2015 (12th International Conference on Intellectual Capital,*